

Innovations in orthodontics

Tiger Dental

Product catalogue



more
space



All top products & accessories at a glance

Contents

Our top product websites	4	Herbst Developer (HD)	50
TopJet Distalizer	6	Product Information	52
Product information	8	Recommended basic equipment list	52
TopJet Distalizer & accesories	12	Mini Mold with Orthoholder set	54
Transpalatal arch TPA	16	Piggy back spring (Huckepackfeder)	56
TopStop direct/TPA space maintainer	17	Product Information	58
PowerScrew	18	Reflex Communicator	60
Product Information	20	Reflex Communicator LED - Sirona	62
PowerScrew and Accessories	24	Reflex Communicator 65/90 mm	64
Recommended basic equipment list	28	Siziliana patient protection glasses	65
Collars for adhesive bonding	30	Intraoral Photography	66
Composite Gun & Saremco applicator	31	Ultrabright dental mirrors, contrastors	68
Collar forceps	31	Contrastors	69
Laboratory forceps with bending tube	32	Lip retractor, cheek retractor	70
Unicorn forceps	32	Cheek retractor	71
Collar extractor set	33	Head/chin cap sets	72
Dual-Top Anchor Systems	34	Progenie head/chin cap set	74
Product Information	36	Progenie head cap	75
JS Jet screw & accessories	38	Vertix – vertical chin cap set	76
Dual-Top accesories	43	Indigo head cap	77
Flex Developer (FD)	44	Chin cap & Helix safety modules	78
Product Information	46		
Accessories & starter set	48		
Recommended basic equipment list	48		
Twist torque measuring wrenches set	49		

Grinding & polishing tools	80
Gyrolan grinding/polishing wheels	82

Additional products	83
GC Ortho Connect	84
Skippy patient pouch	85
Hard metal finishing burr, Torpedo	85

The Team of Tiger Dental	86
---------------------------------	-----------

Some products presented in this catalog could only be sold in certain countries and geographical segments due to selling regulations with our distribution partner. In order it must be assessed in each individual case.

Tel. +43 (0) 5574 435043

Information

Monday - Friday 8.00 – 12.00
Monday, Wednesday, Thursday 12.30 – 16.00 hrs

Ask or a quote or order online
www.tigerdental.com

24/7 and ordering is only available in some countries.

Our TopProdukt websites

Since 2017 we have built separate product websites for the TopProducts. Here you will find all the information regarding each TopProduct at a glance: Videos, instructions, etc. At the bottom of each page you can click to the next TopProduct.

www.topjet-distalizer.com
www.powerscrew-expansion.com
www.flex-developer.com
www.herbst-developer.com



Visit other Top Product websites By clicking on a TopProduct logo you will be redirected to the next website

Dealer search is important for our new clients - simply select a country and the dealers list will be shown



Video instructions illustrate the processes in an comprehensible way - step by step



Documents for download (PDF) Instructions for use, product sheets, declarations of conformity at a glance



TopJet Distalizer

The invisible power pack for your distalisation work

- **Treatment without further manual assistance**
- **Invisible in the mouth**
- **No laboratory work required**
- **Fast insertion in minutes**
- **Individual length adjustment**
- **Easy dosing and post-activation**
- **Distalisation possible on both sides**

www.topjet-distalizer.com



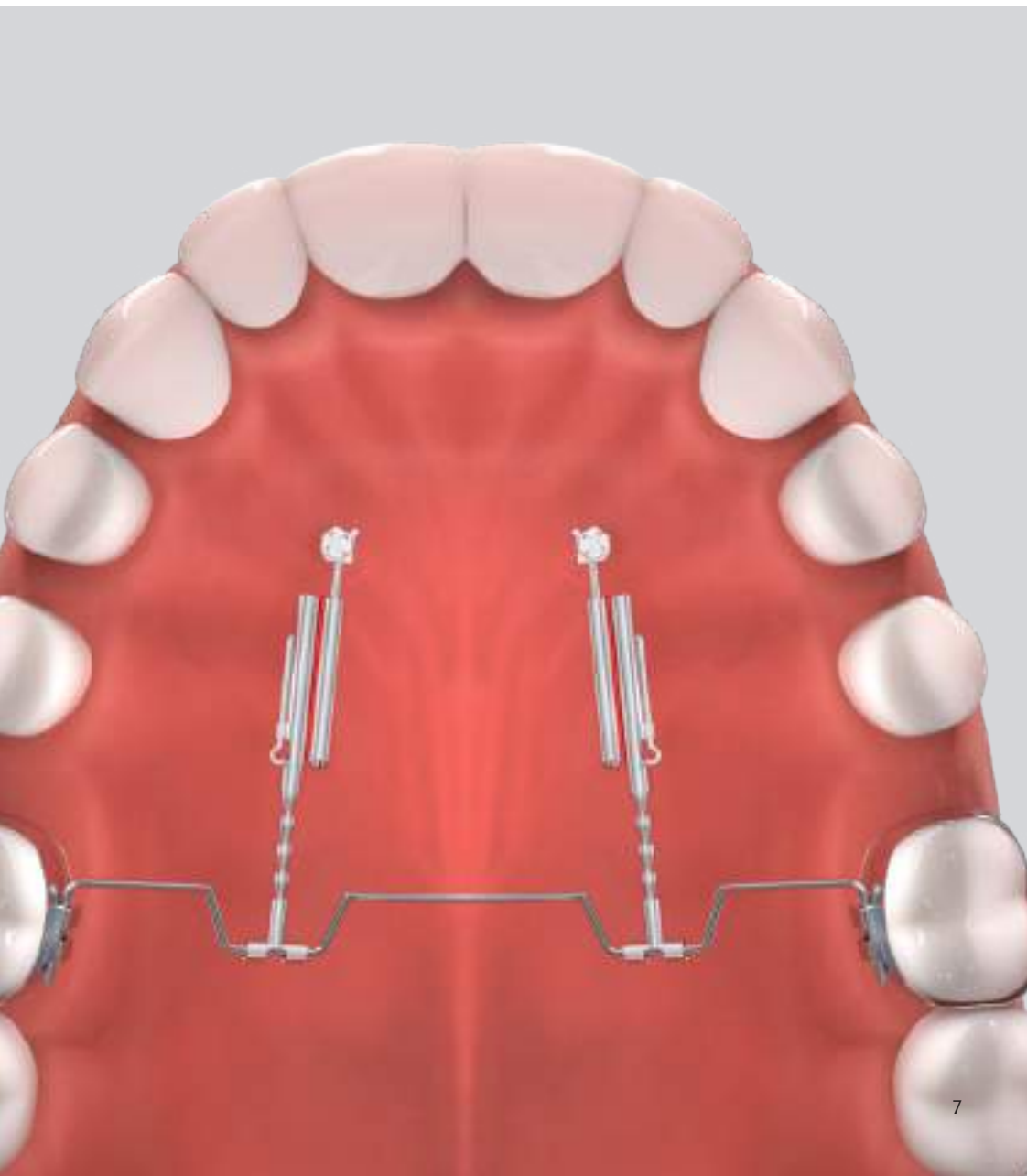

TopJet Distalizer

The TopJet Distalizer is a molar distalisation device with which the posterior maxillary teeth on one or both sides can be distalised approx. 0.8 mm per month, without further manual assistance. It is clipped onto one of the mini anchor screws inserted in the anterior palate and its length can be individually adjusted. In no other device is the insertion so easy and with such a homogeneous effect at the same time. The force is created through an enclosed nitinol tension spring which can be reactivated as needed by retensioning the spring housing. In doing so, a spring hook audibly clicks into place. The reactivation can be performed in 1.6-mm increments.



With 250 cN and 360 cN, the handler has two levels of force available and the TopJet clix is also available as a special design with an extra length of plus 8 mm. With full spring tension, the smallest insertion distance between the mini anchor screw and the transpalatal arch is 14 mm, the largest is 28 mm. At 0.8 mm/month, a molar can be distalised with TopJet Distalizer up to 15 mm.

Selecting the TopJet Distalizer

Black coding = TopJet Distalizer 250 (250 cN) is used in children for sole distalisation of the six-year molars

Red coding = TopJet Distalizer 360 (360 cN) for molar and premolar distalisation. Can be adapted to each situation because of the adjustable force.

Indications

1. Crowding in the front maxilla with sufficiently long jaws (possibly consider prior removal of the upper wisdom teeth!)
2. Protruding front maxillary teeth
3. Lack of space in the maxillary posterior tooth region (e.g. due to hypoplastic lateral incisors, missing or excessively narrow primary teeth or retained premolars).
4. Molar class II occlusion in the setting of migrated maxillary molars (also in the case of skeletal class III and simultaneous dental class II). The TopJet Distalizer can be easily used in one or both sides.

Contraindications

1. Parodontally damaged molars if the force could be too great
2. Short maxilla (distally oriented 2nd molars)

System requirements

- Bands 16/26 with fenestrated Goshgarian locks
- TopJet Distalizer palate arch (according to bending template or prefabricated)
- Dual Top mini anchor screw, type JS, \varnothing 2.0 mm \times 10/12/14 mm, \varnothing 2.5 mm \times 12/14/16 mm in region M4
- Angle piece placed underneath with 25 mm hexagonal screwdriver shaft
- Hook probe as part of the basic dental instrument set to activate and deactivate the TopJet Distalizer
- Ligature cutter to cut through the safety thread
- TopJet forceps: To close the T-connector
- Fixation forceps: To hold the TopJet Distalizer during insertion

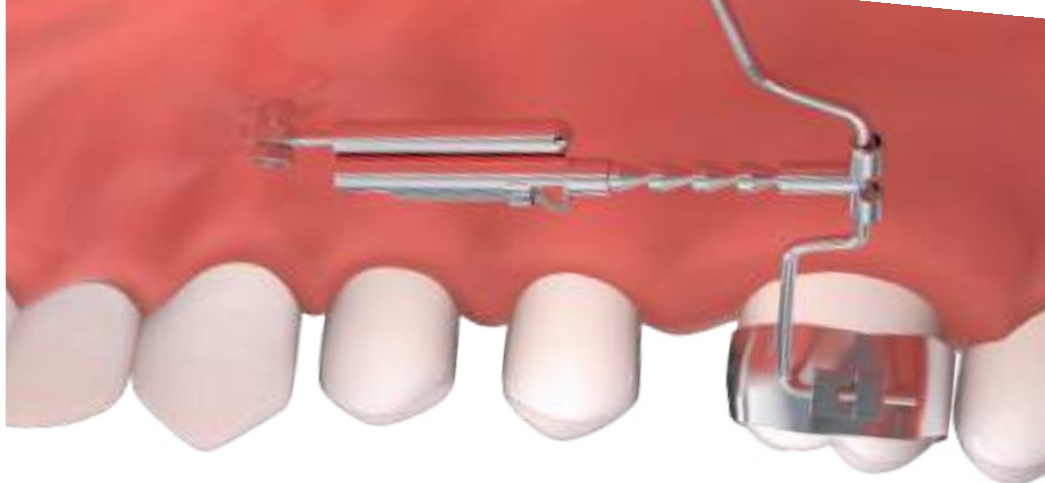

Available variants

TopJet Distalizer 250



TopJet Distalizer 360



TopJet Distalizer 250+8



TopJet Distalizer 360+8



Case study

Leonie K., age 11, significant lack of space, unilateral, right maxilla. Many orthodontists may have had the first premolars extracted. Through distalisation with the TopJet Distalizer, a space is opened within 6 months without further manual assistance.

Mini anchor screws were able to be placed in the anterior palate in a matter of seconds. There are no dental roots or vessels at this site. The entire insertion takes less than 20 minutes.



Technical data

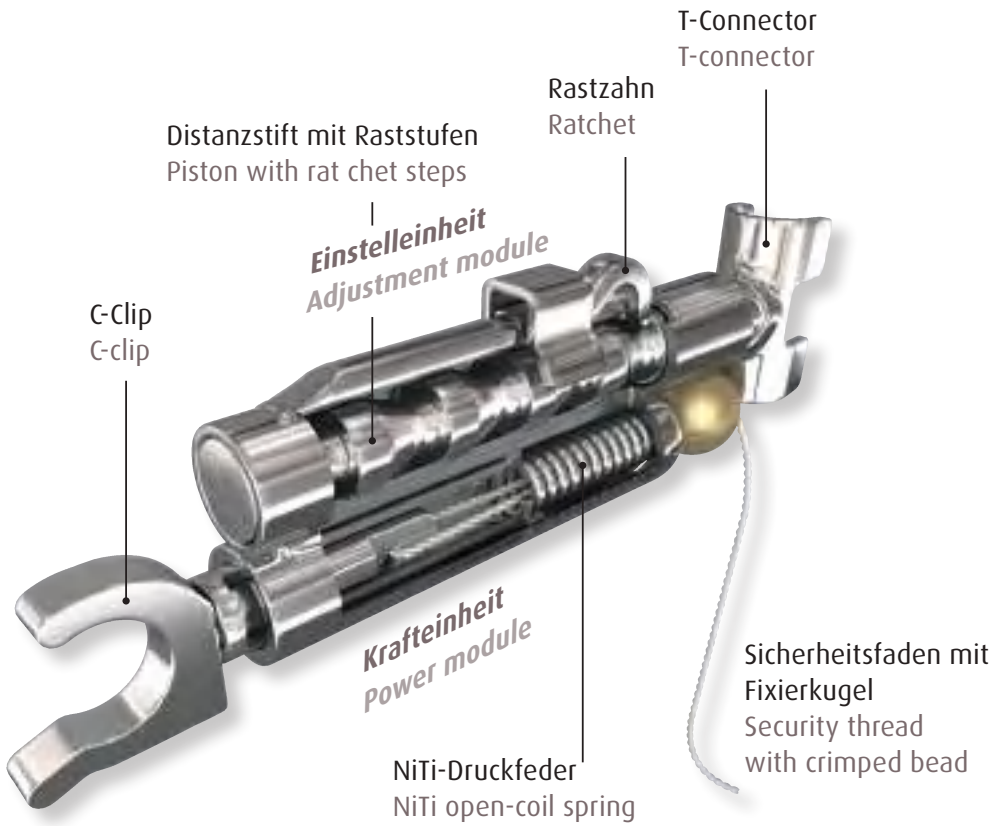

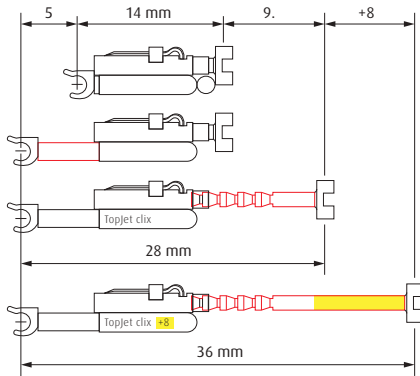

Raststufe	mm	TJ 250	TJ 360
0	0	250 cN	360 cN
1	1,8	210 cN	300 cN
2	3,6	170 cN	240 cN
3	5,4	130 cN	180 cN
4	7,2	90 cN	120 cN
5	9,0	50 cN	60 cN

TopJet 250 = 40 g/Raste, TopJet 360 = 60 g/Raste

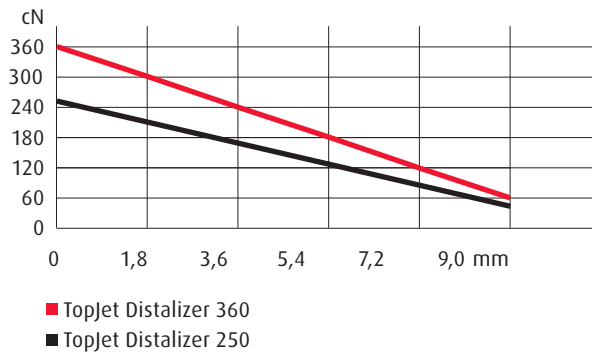

Type	250	360	250+8	360+8
max. Kraftgröße	250 cN	360 cN	250 cN	360 cN
min. Einbaulänge	14 mm	14 mm	22 mm	22 mm
max. Distalisation	14 mm	14 mm	14 mm	14 mm
Raststufen	5	5	5	5
Länge je Raststufe	1,8 mm	1,8 mm	1,8 mm	1,8 mm

TopJet Distalizer & accesories

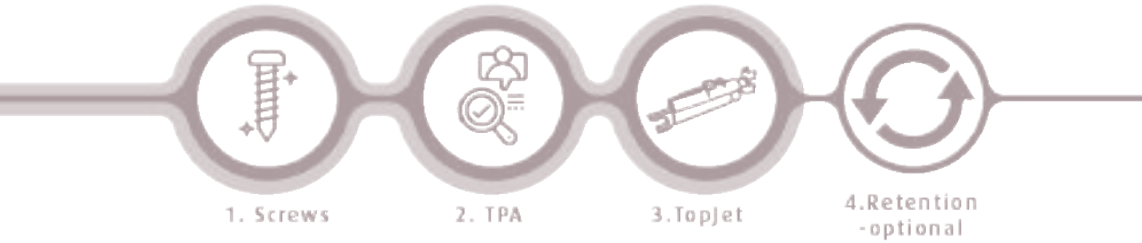

Screws



10459, 10460, 10503
Dual-Top JS Jet Screw with smooth upper shaft, ideal use in the anterior palate. (S. 52)

Screws

Article no.	Designation & contents
10459	Dual-Top JS Jet Screw ø 2,0-JS-010 mm
10460	Dual-Top JS Jet Screw ø 2,0-JS-012 mm
10503	Dual-Top JS Jet Screw ø 2,0-JS-014 mm



TPA

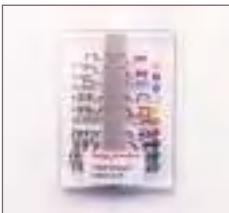

18178, 18179, 18180, 10442, 10443, 10444, 10445, 10446, 10447, 10467, 10479
Palate arches 10 sizes, prefabricated, precise and fast adjustment (S. 16)

Palate arches

Article no.	Designation & contents
18178	Palate arches Size A1, 6 mm, 5 pieces./Pkg.
18179	Palate arches Size A2, 8 mm, 5 pieces./Pkg.
18180	Palate arches Size A3, 10 mm, 5 pieces./Pkg.
10442	Palate arches Size 1, 12 mm, 5 pieces./Pkg.
10443	Palate arches Size 2, 14 mm, 5 pieces./Pkg.
10444	Palate arches Size 3, 16 mm, 5 pieces./Pkg.
10445	Palate arches Size 4, 18 mm, 5 pieces./Pkg.
10446	Palate arches Size 5, 20 mm, 5 pieces./Pkg.
10447	Palate arches Size 6, 22 mm, 5 pieces./Pkg.
10467	Palate arches Size 7, 24 mm, 5 pieces./Pkg.
10479	Palate arches Sortiment, 10 Sizes (6-24 mm) 2 pieces./Pkg.



Distalization - TopJet



10664, 10665, 10666, 10667
TopJet Distalizer

TopJet Distalizer

Article no.	Designation & contents
10664	TopJet Distalizer 250
10665	TopJet Distalizer 250+8
10666	TopJet Distalizer 360
10667	TopJet Distalizer 360+8



Retention - TopStop



10724, 10311 TopStop direct/TPA
space maintaner (S. 17)

Direct or TPA

Article no.	Designation & contents
10311	TopStop TPA, 2 Stk./Pkg.
10724	TopStop direct, 2 Stk./Pkg.



TopStop TPA Video



Accessories



10441 Fixation forceps self-re-
taining, for securely grasping the
TopJet Distalizer during insertion.



10319 T-Connector-Forceps for
closing the T- connector



11137 GC Ortho Connect Flow For
fastening and covering
(S. 102)



10429 Hexagonal screwdriver
shaft for angle piece, M4 position,
113-MJ-204, suitable for JS jet
screw (S. 52)









10686
TopJet Distalizer Demo-Typodont
for patient information

Accessories

Article no.	Designation & contents
10441	Fixation forceps
10319	T-Connector Forceps
10686	TopJet Distalizer Demo-Typodont
11137	GC Ortho Connect Flow 2 x 2,7 g (2 ml)
10429	Hexagonal screwdriver shaft for angle piece, M4 position, 113-MJ-204, suitable for JS jet screw. Lenght: 25 mm

TopJet Distalizer 250

Advised basic equipment

Article No.	Name & content	Recommended quantity	Your order quantity
1. Set the mini anchor screws			
10459	 Dual-Top JS jet screw ø 2,0-JS-010 mm		
10460	 Dual-Top JS jet screw ø 2,0-JS-012 mm	2	
10503	 Dual-Top JS jet screw ø 2,0-JS-014 mm	2	
10429	 Hexagonal screwdriver shaft 113-MJ-204	1	
2. Adapting & Inserting the Transpalatal Arch (TPA)			
10479	Palate arch assortment 10 sizes (6-24 mm) 2 pcs./Pkg.	1	
3. Installing and removing the TopJet Distalizer			
10664	 TopJet Distalizer 250	2	
10441	 Fixation Forceps	1	
10319	 T-Connector pliers	1	
11137	GC Ortho Connect Flow 2 x 2,7 g (2 ml)	1	
4. Retention			
10724	TopStop direct, 2 pcs./Pkg.	1	

 Depending on the age of the patient, the dentition and the distance between screw and palatal arch.

 Instruments for reusing

* (the choice depends on the patient case)

**Configure it
yourself now!**







Configure your basic equipment yourself with our advise!

Depending on your needs, add more products or leave out unneeded products. To order, please enter all items in the column "Your order quantity". We are happy to help!

Starting with the minimum order of all advised products and quantities, you will receive a **TopJet Distalizer demo tyodont (220,00 €) for free.**

TopJet Distalizer 360

Advised basic equipment

Article No.	Name & content	Recommended quantity	Your order quantity
1. Set the mini anchor screws			
10459	 Dual-Top JS jet screw ø 2,0-JS-010 mm		
10460	 Dual-Top JS jet screw ø 2,0-JS-012 mm	2	
10503	 Dual-Top JS jet screw ø 2,0-JS-014 mm	2	
10429	 Hexagonal screwdriver shaft 113-MJ-204	1	
2. Adapting & Inserting the Transpalatal Arch (TPA)			
10479	Palate arch assortment 10 sizes (6-24 mm) 2 pcs./Pkg.	1	
3. Installing and removing the TopJet Distalizer			
10666	 TopJet Distalizer 250	2	
10441	 Fixation Forceps	1	
10319	 T-Connector pliers	1	
11137	GC Ortho Connect Flow 2 x 2,7 g (2 ml)	1	
4. Retention			
10724	TopStop direkt, 2 pcs/Pkg.	1	

 Depending on the age of the patient, the dentition and the distance between screw and palatal arch.

 Instruments for reusing * (the choice depends on the patient case)



TopJet Distalizer - Video

Transpalatal arch (TPA)

The prefabricated TopJet palate arches can be adjusted in seconds and thus make insertion quicker.

10 sizes: 6, 8, 10, 12, 14, 16, 18, 20, 22, 24 mm

Rule of thumb for determining size:

“The intermolar distance (fossa centralis) generally corresponds to the TPA size needed.”

Formula examples

Intramolar distance 44 mm: $44 - 30 = \text{size } 14$

After subtracting “30 mm” ($2 \times 15 \text{ mm}$), we obtain the TPA order size (= F distance). This TPA is then to be adjusted accordingly (see instructions for use).

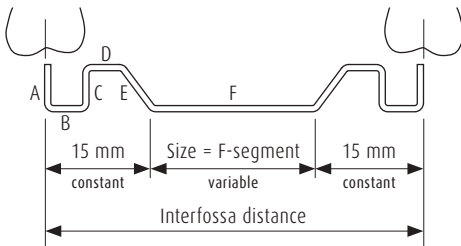

Bending instructions

1. Coffin lid bend:

Creates the basic shape of the TPA. The F-segment should remain straight.

2. Expansion bend:

The TPA should also expand the molars during distalization.

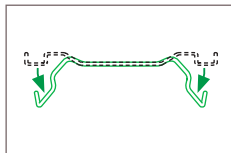

1. Coffin lid bend basic shape

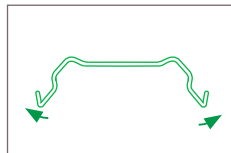

2. Expansion bend: End by bending outwards

Article no.	Designation & contents
18178	Palate arch size A1, 6 mm, items/pack
18179	Palate arch size A2, 8 mm, 5 items/pack
18180	Palate arch size A3, 10 mm, 5 items/pack
10442	Palate arch size 1, 12 mm, 5 items/pack
10443	Palate arch size 2, 14 mm, 5 items/pack
10444	Palate arch size 3, 16 mm, 5 items/pack
10445	Palate arch size 4, 18 mm, 5 items/pack
10446	Palate arch size 5, 20 mm, 5 items/pack
10447	Palate arch size 6, 22 mm, 5 items/pack
10467	Palate arch size 7, 24 mm, 5 items/pack
10479	Palate arch assortment, 7 sizes (12-24 mm) each 2 items/pack



Position bend D-segment: This bend helps to bring the D-segment and thus the T-Connector into the right distance from the gingiva.

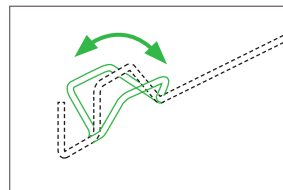

D-segment position bend possible in both directions

Action: Segments C and E are bent one after the other and to the same extent towards the middle.

Result: The D-segment and the T-Connector of the TopJet Distalizer gains more distance from the mucosa (if the reverse is done, less distance).

TopStop direct & TPA space maintainer

The **TopStop Space Maintainers** are telescopically adjustable connections between the mini anchor screw and the molar which are adhered using **RMbond®**. This results in a rigid connection which prevents migration of the molars.

The **TopStop TPA** is used as a replacement after the use of a **TopJet** between the mini anchor screw and the TPA.

The **TopStop direct** can be used directly between the mini anchor screw in the anterior palate and the Goshgarian lock on the molar band.

Single or double-sided applications are possible in each case. In particular following premolar extractions, if the molars are to be anchored without further manual assistance.

Article no.	Designation & contents
10311	TopStop TPA, 2 items/pack
10724	TopStop direct, 2 items/pack



TopStop direct, beidseitig



TopStop TPA, einseitig



TopStop TPA



TopStop direct

Installation of the TopStop TPA



1

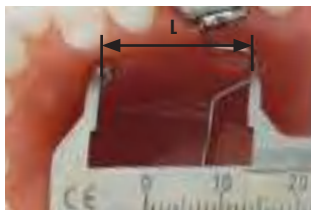

2 Measuring the distance "L"

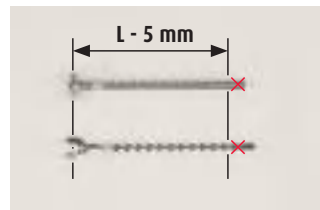

3 Shortening

◀ *PowerScrew* ▶

**More stability and variability
for your safe expansion!**

- **Small body, high stability**
- **Grows as required with changeable hexagonal nut**
- **Easy self activation by the patient with precisely fitting flat spanner**
- **More comfort as a result of the rounded design**
- **Invisible in the mouth**

www.powerscrew-expansion.com







PowerScrew

The PowerScrew is a double telescope screw for use in palatal expansion devices. It is available in five sizes  (8, 10, 12, 14 and 16 mm). Its retention arms are extremely stable for greatest forces and torques. Activation with the flat spanner can be done quickly and simple by the patient on the hexagonal nut. By changing the hexagonal nut for the next biggest, the expander can be used to continue expanding.

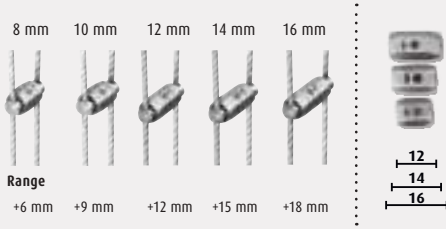
Five sizes



 Depending on the size of the palate.

The PowerScrew can be used for dental and skeletal expansion of a narrow upper jaw in children, adolescents and adults. It is used for dental braces devices (HAAS-type), dental cap splint devices, for the Hybrid Expander (partially miniscrew-borne and tooth-borne RME devices) and for purely miniscrew-borne expanders (MICRO2/MICRO4 expander).

Bone Borne		Tooth Borne
MICRO 2		HAAS-type
MICRO 4		Kappenschienen
Hybrid		

Indications

Expansion of narrow upper jaws in children, adolescents and adults.

Patientenfälle

Claudia is 11 years old patient. She had a significant narrow palate which needed to be expanded. Thanks to the bone borne expander (MICRO 2) she could easily and slowly expand her maxilla by activating the MICRO 2 with the wrench.



Michael, 25 years old, has significant crowding due to lack of space in the anterior maxilla. With the MICRO 4 and the clinical "expansion protocol"**, surgery-free expansion was possible.



Andrea, 10 years old. Her molars were distalized in the first step to create space for her incisors to erupt.

In the second step the hybrid expander is used to widen the palate while retaining the distalized molars.



Das System

MICRO 2
Kids Max.
13 years old*

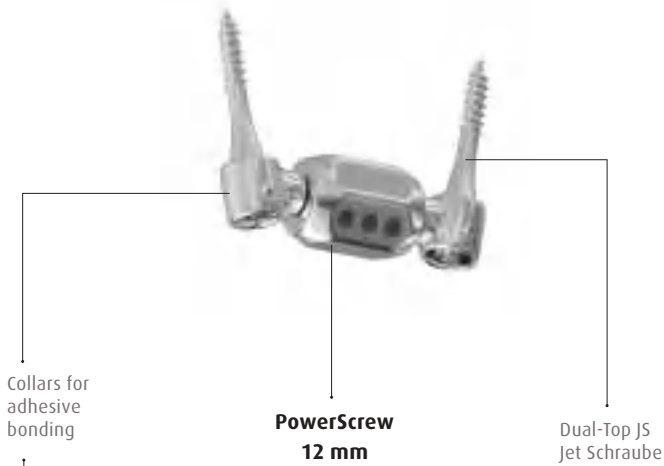

MICRO 4
Older than
13 years old*

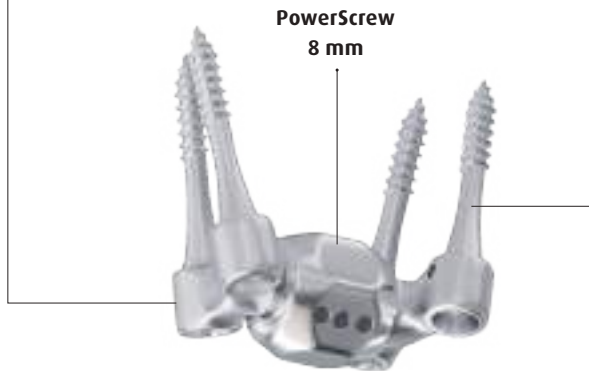

Your benefits



High stability

The PowerScrew and its support arms are extremely rigid against the greatest forces and torques. This allows a safe and effective expansion.



Changeable hexagonal nut

For very narrow palates, a PowerScrew 8 expander is required. The replacement of the next larger hexagon nut (12/16) allows a widening of up to 18 mm with the same device.



Easy self activation

Easy activation by the patient with an ergonomic open-end wrench for turning of the hex nut. of the PowerScrew.

Technical information

The components of the PowerScrew

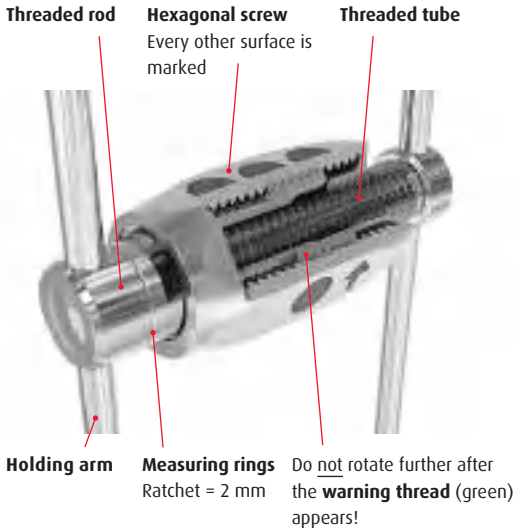

Technical information

Screw body (size)	Max. expansion path	Measuring rings
8 mm	6 mm	3 ring
12 mm	12 mm	5 ring
16 mm	18 mm	7 ring

Expansion per rotated surface

Surfaces	Expansion
6	1.0 mm (= 1 rotation)
1	0.17 mm

Start of rotation

- Every surface counts
- Every other surface is marked
- Direction of rotation from the teeth to the tongue

How does activation take place?

Please open the mouth as wide as possible. The spanner is to be placed on the hexagon screw of the screw body such that the handle is near the upper front teeth (Fig. right).

Move the spanner until it is just before the lower teeth (on the tongue). Then detach the spanner, rotate 180° around the longitudinal axis, place back on the upper teeth and move downwards once again (= 1 surface rotated).

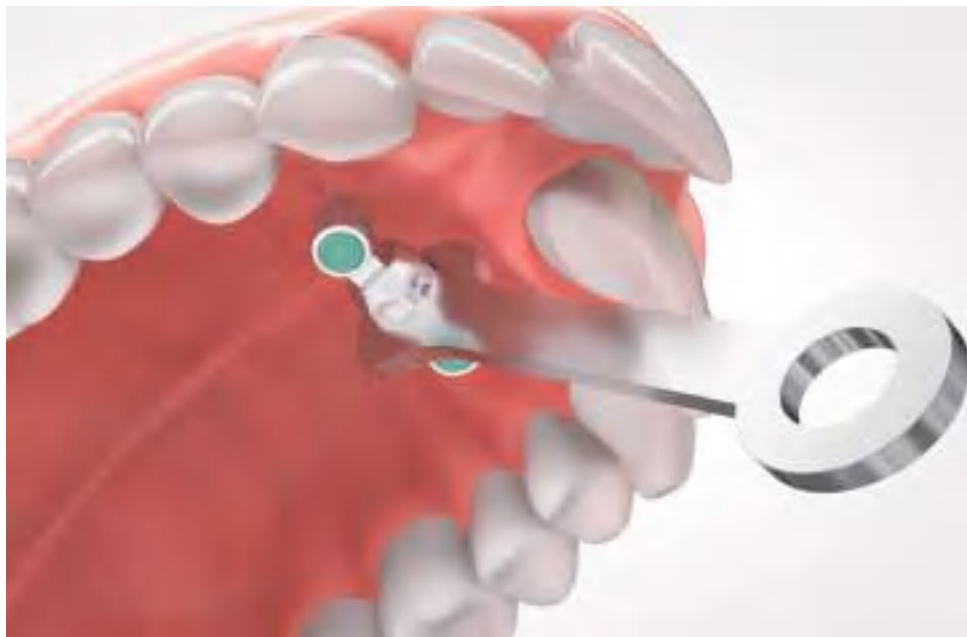
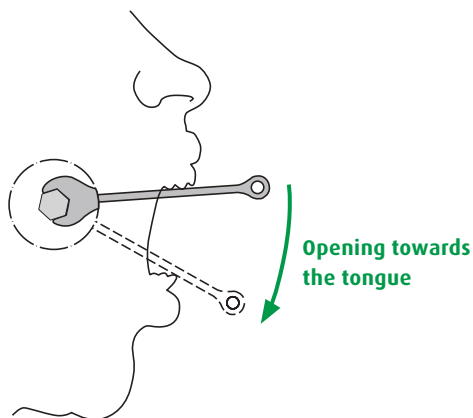

Activation of the PowerScrew with the flat spanner

PowerScrew – Accessories overview

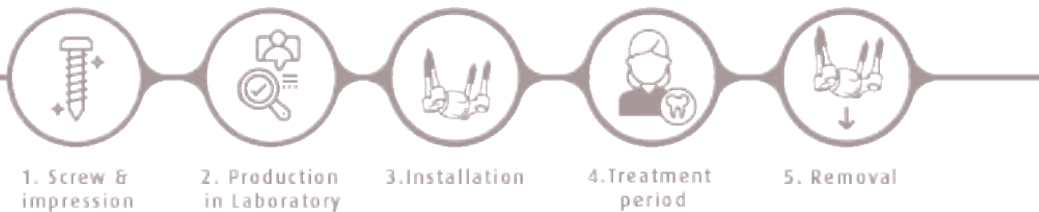

1. Screws and impression



10615, 10616, 10566 Dual-Top JS Jet screw with smooth upper shaft, ideal use in the anterior palate



10429 Hexagonal screwdriver shaft for angle piece, M4 position, 113-MJ-204, suitable for JS jet screw

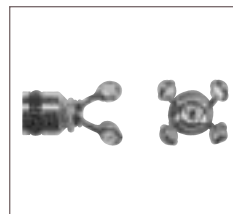

10622 Transfer caps

Article no.	Designation & contents
10615	Dual-Top JS jet screw \varnothing 2,5-JS-012 mm
10616	Dual-Top JS jet screw \varnothing 2,5-JS-014 mm
10566	Dual-Top JS jet screw \varnothing 2,5-JS-016 mm
10429	Hexagonal screwdriver shaft, for angle piece, M4 position, 113-MJ-204, length: 25 mm
10622	Transfer caps, 2 pcs/kg.



2. Production in the laboratory

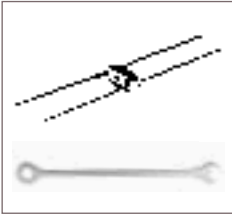

11011, 18222, 10965, 18215, 10967 PowerScrew with holding arms, flat spanner



10593, 10841 Collars for adhesive bonding with hard metal finishing burr Connection elements between treatment device and mini anchor screw



10597 Laboratory pliers with bending tube



10986 Flat wire Connection material for laser welding between the PowerScrew and the adhesive sleeve, for MICRO2, MICRO4



10701 Laboratory analogue

Article no.	Designation & contents
11011	PowerScrew 8, with welded holding arms, flat spanner
18222	PowerScrew 10, with welded holding arms, flat spanner
10965	PowerScrew 12, with welded holding arms, flat spanner
18215	PowerScrew 14, with welded holding arms, flat spanner
10967	PowerScrew 16, with welded holding arms flat spanner

Article no.	Designation & contents
10986	Flat wire - 3 items of 3 cm each
10701	Laboratory analog, 4 items/Pkg.
10593	Profiled adhesive collars, 4 items/Pkg.
10841	Collars for adhesive bonding, 4 pcs/pkg
10597	Laboratory pliers with bending tube



Video for the production of the MICRO 4 in the laboratory



3. Installation



10632 Plastic spatula to mix the phase II adhesive composite



10868 Saremco Applicator



10332 Phase II Part A adhesive composites, 6 g



10333 Phase II Part B adhesive composites, 6 g

Article-Nr.	Description & Content
10632	Plastic spatula, 3 pcs./Pkg.
10332	Phase II Part A adhesive composites, 6 g
10333	Phase II Part B adhesive composites, 6 g
10868	Saremco Applicator



4. Treatment period



10923 PowerScrew safety scale
Spring scale for measuring the torque on the flat spanner of the PowerScrew



10873 PowerScrew open-ended spanner



10968, 10969 PowerScrew
Hexagonal screw,
Sizes: 12, 14 and 16 mm



10657 Typodont Hybrid-Hyrax
for employee training and patient demonstration

Interchangeable Hexagonal nut

Enables additional expansion path with the same equipment.

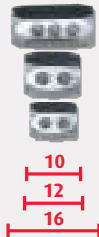

Article-Nr.	Description & Content
10923	PowerScrew safety scale
10873	PowerScrew open-ended spanner
10968	PowerScrew 12 hexagonal screw, 3 pcs./Pkg.
10969	PowerScrew 16 hexagonal screw, 3 pcs./Pkg.
10657	Hybrid Hyrax Expander Typodont – complete, white
19069	PowerScrew 14 hexagonal screw, 3 pcs./Pkg.
19067	PowerScrew 10mm, 3pcs./Pkg.



5. Removal



10892 Collar extractor set for pressure-free removal of the collars for adhesive bonding from the screw head (S. 33)















10611 Collar forceps for quick and easy removal of synthetic material on the collar of the Dual-Top® JS jet screw.

Article-Nr.	Description & Content
10892	Collar extractor set (for handpiece)
10611	Pliers for collars

Configure it yourself now!



PowerScrew Recommended basic equipment list

Article no.	Name & content	Advised quantity	Your order quantity
1. Set the mini anchor screws & impression			
10615	 Dual-Top JS jet screw ø 2.5-JS-012 mm		
10616	 Dual-Top JS jet screw ø 2.5-JS-014 mm	2*	
10566	 Dual-Top JS jet screw ø 2.5-JS-016 mm	2*	
10429	 Hexagonal screwdriver shaft 113-MJ-204, length: 25 mm	1	
10622	Transfer caps, 2 pcs/pkg	1	
2. Production of the expander in the laboratory			
11011	PowerScrew 8, with welded holding arms, flat spanner		
10965	 PowerScrew 12, with welded holding arms, flat spanner	2	
10967	 PowerScrew 16, with welded holding arms, flat spanner		
10701	 Laboratory analogue long, 4 pcs/pkg	1	
10841	 Collars for adhesive bonding, straight, 4 pcs/pkg	1*	
10986	 PowerScrew flat wire - 3 pcs per 5 cm	-	
4. Installation of the Expander			
10332	Phase II Part A adhesive composite, 6 g, 3 pcs/pkg	1	
10333	Phase II Part B adhesive composite, 6 g, 3 pcs/pkg	1	
10765	Plaster blocks with laboratory analogue	1	
10632	 Kunststoffspatel, 3 Stk./Pkg.		
5. Removal of the Expander			
10892	 Collar extractor set H /collar extractor W, needle holder, hard metal	1	
10611	 Pliers for collars	1	

 Abhängig von der Größe des Gaumens.
  Zum Lötten/Schweißen
  Für Laser.
  wiederverwendbare Instrumente.

* (die Wahl hängt vom Patientenfall ab)

Configure your basic equipment yourself with our advise!

Depending on your needs, add more products or leave out unneeded products. To order, please enter all items in the column "Your order quantity". We are happy to help!

Starting with the minimum order of all advised products and quantities, you will receive a **TopJet Distalizer demo typodont (220,00 €) for free.**

MICRO2 / MICRO4

Bone borne



The MICRO appliances are pure bone-supported expanders. The MICRO2 uses two mini screws for expansion of patients up to 13 years of age. MICRO4 is recommended for patients over 13 years of age. It is based on four mini screws in the palate.

MICRO 2

Is used with two \varnothing 2.5mm mini screws (L 12/14mm). Recommended for the expansion of children and teenagers up to 13 years of age.

7-13 years (MICRO2)

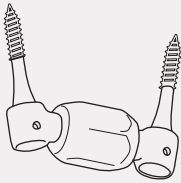

MICRO 4

Is used with four \varnothing 2.5mm mini screws (L 14/16mm). Recommended for the expansion of patients over 13 years of age.

14-99 years (MICRO4)

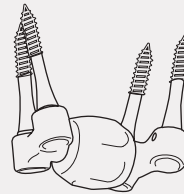

How to choose the screws?

The screw is chosen depending on the patient palate.

For expansions a screw with 2,5mm diameter ensures maximal stability. The screws are available in 12, 14 and 16 mm of length. The decisions of the screws lengths depend on the dentition and form of the palate.

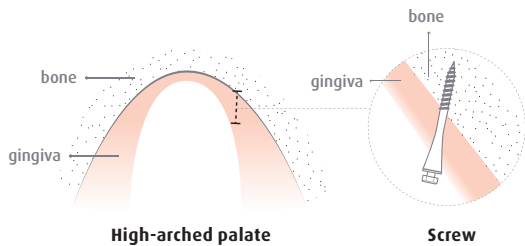

Collars for adhesive bonding, straight/profiled

The collars for adhesive bonding form a secure and detachable connection between the Hyrax screw and mini anchor screw. The collars are welded onto the retention arms of the expander screw. They are the connection elements between the mini anchor screw (MAS) and the hyrax expander.

For insertion, the collars are pushed over the head of the MAS and filled with self-curing composite. Excess composite can escape from an outflow opening. This connection is highly resilient (up to 400 N) and can be detached during removal easily and in seconds (see collar extractor).

Better wear comfort and use with the collars for adhesive bonding “straight” through:

- lower height (0.5 mm)
- rounded edges

Article no.	Designation & contents
10593	Collars for adhesive bonding, profiled, 4 items/pack
10841	Collars for adhesive bonding, straight, 4 items/pack



Collars for adhesive bonding on jet screw



Collars for adhesive bonding “profiled” (left) and “straight” (right)



The collars are filled using a composite gun and caps dispenser.



Only when “spaghetti” exits from the holes of the collar on the side is it completely filled.

Composite gun for caps dispenser & Saremco applicator

The disposable composite guns are ideally suited for filling the collars for adhesive bonding using a caps dispenser.

Article no.	Designation & contents
10728	Composite gun, orange, tubes and plugs, 3 items/pack
10868	Saremco applicator



Collar forceps

- for grasping the collar
- for compressing the anterior holding arm
- for grasping the holding arm
- for removing remaining synthetic material between the hexagonal plate and gingival plate

Article no.	Designation & contents
10611	Collar forceps



PowerScrew laboratory forceps with bending tube

For securely holding and bending the holding arm of the PowerScrew.



Article no.	Designation & contents
10597	PowerScrew laboratory forceps with bending tube



Unicorn forceps

- for painless removal of cap splint devices



Article no.	Designation & contents
10624	Unicorn forceps with bud burr



1. Drill opening in acrylic



2. Push teeth in individually



3. Device is painlessly removed.

Collar extractor set

The collar extractor makes gentle removal of collar-supported palatal suture expansion devices possible. In this process, the removal finger grasps the lower edge of the collars for adhesive bonding. After removing the synthetic material above the head of the screw, the collar can be pushed from the mini anchor screw using a pin.

Contents

- 1 item collar extractor "for angle piece"
- 1 item needle holder
- 1 item hard metal finishing burr
- Thread grease

Article no.	Designation & contents
10892	Collar extractor set Contents: Collar extractor, needle holder, hard metal finishing burr, thread grease
11124	Hexagonal driver shaft for contra angel



Collar extractor
for angle piece



1. Hold with needle
holder



2. Position on collar



3. Push collar out by
rotating the screw

Dual-Top™ *Anchor Systems*

Orthodontic anchoring system for immediate load-bearing

- **Cost-effective, simple, minimally invasive and safe method**
- **Permits immediate load-bearing and thus can be used immediately**
- **Special head shapes for easy use**
- **With gingival protection for better patient comfort**
- **High degree of primary stability and durability, even during longer treatment periods**



Dual-Top™ Anchor Systems

Dual-Top™ provides a system which enables practically all forms of skeletal anchoring with mini screws known in orthodontics.

Worldwide, since 2002, several thousand orthodontic treatments have been successfully performed or accompanied by Dual-Top™ screws. The special thread design ensures the greatest possible primary stability and yet allows a minimally invasive insertion under local anaesthesia which causes the patient little or no discomfort. All Dual-Top™ screws are self-drilling and self-tapping.

The Dual-Top™ Anchor System has been consistently further developed since its market launch. To fulfil the various tasks of skeletal anchoring in an elegant and user-friendly way, the variable head shapes of the Dual-Top™ mini screws match the corresponding orthodontic treatment tasks. Whether tension springs, elastic chains, partial arches or orthodontic devices, the Dual-Top™ Anchor System offers the right solution.

The material titanium alloy (Ti-6Al4V) ASTM F136, has been successfully used for years in many areas of implantology and thus meets all requirements in orthodontics.

Dual-Top™ mini anchor screws (MAS)

The material titanium alloy (Ti-6Al4V) ASTM F136, has been successfully used for years in many areas of implantology and thus also meets all requirements in orthodontics.



Dual-Top Jet screw

Osseointegration

is a recurrent issue in orthodontic mini implants. In animal studies, the DUAL-TOP mini anchor screws demonstrate that there is also deep implant-bone contact in the cortical region. However, what is astonishing is the additive bone growth in animal studies (see picture). The material used, Ti-6Al 4V, as well as the very smooth implant surface prevent "ingrowth" as in the case of dental implants. For this reason, removal after the end of treatment is easy and can be done without anaesthesia.

Appropriate insertion sites

In principle, all vestibular and palatal regions with attached gingiva are suitable. In this case, the space situations between and next to the roots must be clarified beforehand using X-ray images. An insertion lingually and in the fold or through loose mucosa is not recommended.



Additive bone growth along the screws (animal experiments, University of Münster)

Secure hold during insertion

The head of Dual Top screws have an external hex as well as a cross-slit for inserting the screw. With the self-retaining hexagonal socket spanner in position, a secure, rotation-resistant and stable-angle hold when the screw is screwed in is guaranteed. Additional general information on inserting Dual-Top screws can be found in the Dual-Top manual.

Manual screwdriver or implant angle piece?

The advantage of the screwdriver is the good capture of the axial direction. Other than vestibularly and interradicularly, it is hardly applicable on the palatal side. Nowadays, nearly all screws are inserted at 30 rpm with the implant angle piece. A 40-mm long hexagonal screwdriver shaft is used for this purpose. Palatally, the attachment is 25 mm; retromolarly, 21 mm long.

Screw rule

The following basic rule applies in principle: "The longer and thicker the mini anchor screw selected, the better the osseointegration will be and thus the more durable and reliable the hold will be." The Dual-Top system enables diameters of 2.0 and 2.5 mm and lengths of 10, 12, 14 and 16 mm.

Possible contraindications

1. The Dual-Top™ anchor screw should not be used if an infection is present.
2. Insertion should also be avoided in cases of known hypersensitivity to titanium alloy (Ti-6Al4V).

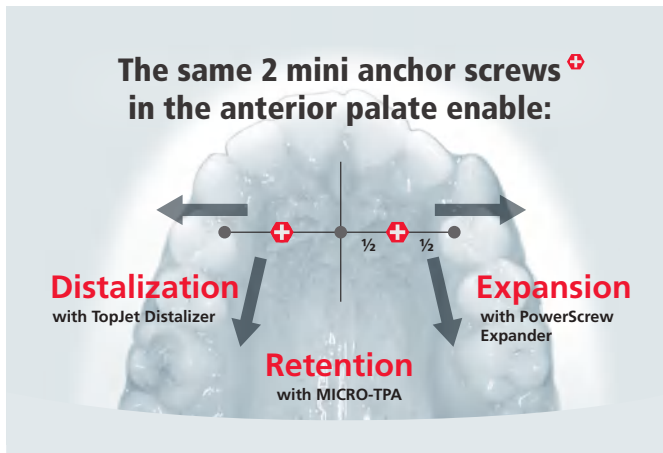

top: TopJet Distalizer
bottom: PowerScrew Expander

M4 position The screw position for TopJet Distalizer & PowerScrew Expander. The M4 position is found in the half of the line between the palatal bump of the first premolar and the intersection with the median line.

JS Jetschraube & Accesories

Dual-Top JS Jet Screw

- for TopJet Distalizer & PowerScrew Expander
- with smooth upper shaft
- ideal use in the anterior palate
- Ø: 2.0 / 2.5 mm, L: 10 / 12 / 14 / 16 mm



JS Jetschraube (doppelseitig)
mit TopJet Distalizer (einseitig)



JS Jetschraube (doppelseitig)
mit PowerScrew Hybrid-Expander



Dual-Top JS Jet screw



Hexagonal screwdriver shaft for
contra-angle handpiece,
113-MJ-204, length: 25 mm, for
M4 position, accessories for
JS Jet Screw

Article-Nr.	Description & Content
10459	Dual-Top JS Jetscrew ø 2,0-JS-010 mm
10460	Dual-Top JS Jetscrew ø 2,0-JS-012 mm
10503	Dual-Top JS Jetschraube ø 2,0-JS-014 mm
10615	Dual-Top JS Jetscrew ø 2,5-JS-012 mm
10616	Dual-Top JS Jetscrew ø 2,5-JS-014 mm
10566	Dual-Top JS Jetscrew ø 2,5-JS-016 mm
10429	Hexagonal screwdriver shaft, for hand- piece, M4 position, 113-MJ-204, length: 25 mm

**Pflege des Hexa-
gonalaufsatzes mit
Silikonspray ist
empfehlenswert!**

G2-Schraube & Accesories

Dual-Top G2-Screw

- for partial sheets, slot .022"× .028", elastic chains and wire ligatures.
- Ø: 1.4 / 1.6 / 2.0 mm, L: 6 / 8 / 10 mm



10298, 10299, 10296, 10275, 10276, 10297, 10277, 10278
Dual-Top G2-screw



10301 Screwdriver shaft, short, for contra-angle handpiece, 113-GD-201, length: 20 mm

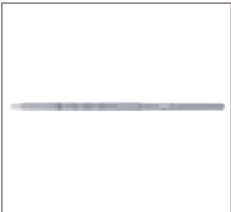

1300 Screwdriver Shaft, cross-recess, long, for Screwdriver Handle, 113-GD-101, length: 70 mm



1348 Hexagonal screwdriver shaft, long, for screwdriver handle, 113-MJ-103, length: 70 mm



10349 Hexagonal screwdriver shaft, for handpiece, 113-MJ-203, length: 20 mm

Article-Nr.	Description & Content
10298	Dual-Top G2-Screw with open cross-head ø 1,4-G2-006 mm
10299	Dual-Top G2-Screw with open cross-head ø 1,4-G2-008 mm
10296	Dual-Top G2-Screw with open cross-head ø 1,6-G2-006 mm
10275	Dual-Top G2-Screw with open cross-head ø 1,6-G2-008 mm
10276	Dual-Top G2-Screw with open cross-head ø 1,6-G2-010 mm
10297	Dual-Top G2-Screw with open cross-head ø 2,0-G2-006 mm
10277	Dual-Top G2-Screw with open cross-head ø 2,0-G2-008 mm
10278	Dual-Top G2-Screw with open cross-head ø 2,0-G2-010 mm
10301	Screwdriver shaft, for contra-angle hand- piece, 113-GD-201, length: 20 mm
10300	Screwdriver Shaft, cross-recess, for Screwdriver Handle, 113-GD-101, length: 70 mm
10348	Hexagonal screwdriver shaft, for screwdr- iver handle, 113-MJ-103, length: 70 mm
10349	Hexagonal screwdriver shaft, for hand- piece, 113-MJ-203, length: 20 mm

JA Standard screw & Accesories

Dual-Top JA Standard screw

- for elastic chains and wire ligatures,
- Ø: 1.4 / 1.6 / 2.0 mm, L: 6 / 8 / 10 mm



JA Schraube mit Elastikkette



JA Schraube mit Intrusion



10281, 10279, 10265, 10266, 10267, 10280, 10268, 10269
Dual-Top JA Standard screw

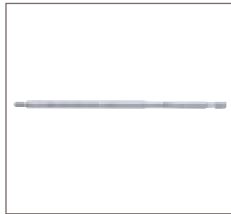

10262 Screwdriver shaft, cross recess, for screwdriver handle, 113-MD-101, length: 70 mm



10261 Screwdriver shaft, cross-recess, for contra-angle handpiece, 113-MD-201, length: 18 mm



10348 Hexagonal-SchraubendreherSchaft, für Schraubendreher-Griff, 113-MJ-103, Länge: 70 mm



10349 Screwdriver shaft, cross-recess, for contra-angle handpiece, 113-MD-201, length: 18 mm

Article-Nr.	Description & Content
10281	Dual-Top JA Standard screw ø 1,4-JA-006 mm
10279	Dual-Top JA Standard screw ø 1,4-JA-008 mm
10265	Dual-Top JA Standard screw ø 1,6-JA-006 mm
10266	Dual-Top JA Standard screw ø 1,6-JA-008 mm
10267	Dual-Top JA Standard screw ø 1,6-JA-010 mm
10280	Dual-Top JA Standard screw ø 2,0-JA-006 mm
10268	Dual-Top JA Standard screw ø 2,0-JA-008 mm
10269	Dual-Top JA Standard screw ø 2,0-JA-010 mm
10261	Screwdriver shaft, cross-recess, for contra-angle handpiece, 113-MD-201, length: 18 mm
10262	Screwdriver shaft, cross recess, for screwdriver handle, 113-MD-101, length: 70 mm
10348	Hexagonal screwdriver shaft, for screwdriver handle, 113-MJ-103, length: 70 mm
10349	Hexagonal screwdriver shaft, for handpiece, 113-MJ-203, length: 20 mm

JB Knopfschraube & Accesories

Dual-Top JB Knopfschraube

- ideally suited for NiTi springs
- NiTi tension springs, with 1 safety eye
- Ø: 1.4 / 1.6 / 2.0 mm, L: 6 / 8 / 10 mm



10354, 10326, 10315, 10312, 10302, 10303, 10313, 10314
Dual-Top JB Knopfschraube

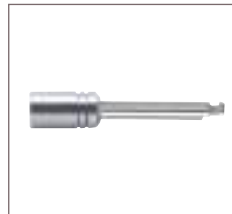

10305 Screwdriver shaft, for handpiece 113-JB-201, length: 25 mm



10304 Screwdriver Shaft, for Screwdriver Handle, 113-JB-101, length: 70 mm



Dual-Top NiTi Zugfeder (S. 49)

Article-Nr.	Description & Content
10354	Dual-Top JB Knopfschraube ø 1,4-JB-006 mm
10326	Dual-Top JB Knopfschraube ø 1,4-JB-008 mm
10315	Dual-Top JB Knopfschraube ø 1,6-JB-006 mm
10312	Dual-Top JB Knopfschraube ø 1,6-JB-008 mm
10302	Dual-Top JB Knopfschraube ø 1,6-JB-010 mm
10303	Dual-Top JB Knopfschraube ø 2,0-JB-006 mm
10313	Dual-Top JB Knopfschraube ø 2,0-JB-008 mm
10314	Dual-Top JB Knopfschraube ø 2,0-JB-010 mm
10305	Screwdriver shaft, for handpiece 113-JB-201, length: 25 mm
10304	Screwdriver Shaft, for Screwdriver Handle, 113-JB-101, length: 70 mm

JD Bracket-Kopf-Schraube & Accesories

Dual-Top JD Bracket-Kopf-Schraube

- for partial sheets as well as fast and convenient ligatures, slot .022"× .028".

- Ø: 1.4 / 1.6 / 2.0 mm, L: 6 / 8 / 10 mm



10341, 10340, 10342, 10344, 10345, 10346, 10347
Dual-Top JD Bracket-Kopf-Schraube



10348 Hexagonal screwdriver shaft, for screwdriver handle, 113-MJ-103, length: 70 mm



10349 Hexagonal screwdriver shaft, for handpiece, 113-MJ-203, length: 20 mm

Article-Nr.	Description & Content
10341	Dual-Top JD Bracket-Kopf Schraube ø 1,4-JD-006 mm
10340	Dual-Top JD Bracket-Kopf Schraube ø 1,4-JD-008 mm
10342	Dual-Top JD Bracket-Kopf Schraube ø 1,6-JD-006 mm
10343	Dual-Top JD Bracket-Kopf Schraube ø 1,6-JD-008 mm
10344	Dual-Top JD Bracket-Kopf Schraube ø 1,6-JD-010 mm
10345	Dual-Top JD Bracket-Kopf Schraube ø 2,0-JD-006 mm
10346	Dual-Top JD Bracket-Kopf Schraube ø 2,0-JD-008 mm
10347	Dual-Top JD Bracket-Kopf Schraube ø 2,0-JD-010 mm
10348	Hexagonal screwdriver shaft, for screwdriver handle, 113-MJ-103, length: 70 mm
10349	Hexagonal screwdriver shaft, for handpiece, 113-MJ-203, length: 20 mm

Care of the hexagonal attachment with silicone spray is recommended!

Dual-Top Accesories



10259, 10260 Pilotbohrer
ø 0,8/1,0 mm



10257 Schraubendreher-Griff

Article-Nr.	Description & Content
10257	Schraubendreher-Griff 111-010
10259	Pilotbohrer 112-MC-201, ø 0,8 mm, für Schraube ø 1,4 und 1,6 mm
10260	Pilotbohrer 112-MD-201, ø 1,0 mm, für Schraube ø 2,0 mm

Dental ratchet manual set

For all Dual-Top and OrthoLox hexagonal screwdriver shafts that also fit on the contra-angle hand-piece.

With the dental ratchet, the last or first turns can be carried out manually and safely when inserting and removing the screw.

Article-Nr.	Description & Content
10917	OL RAT 000 Ratsche zur Schrauben-Insertion
10918	OL DAD 000 Dental-Adapter für Ratsche



Flex.😊 Developer

**For easy, efficient and convenient
Class II correction!**

- fast chairside installation
- high patient comfort through encapsulated end pieces
- no reworking necessary

www.flex-developer.com



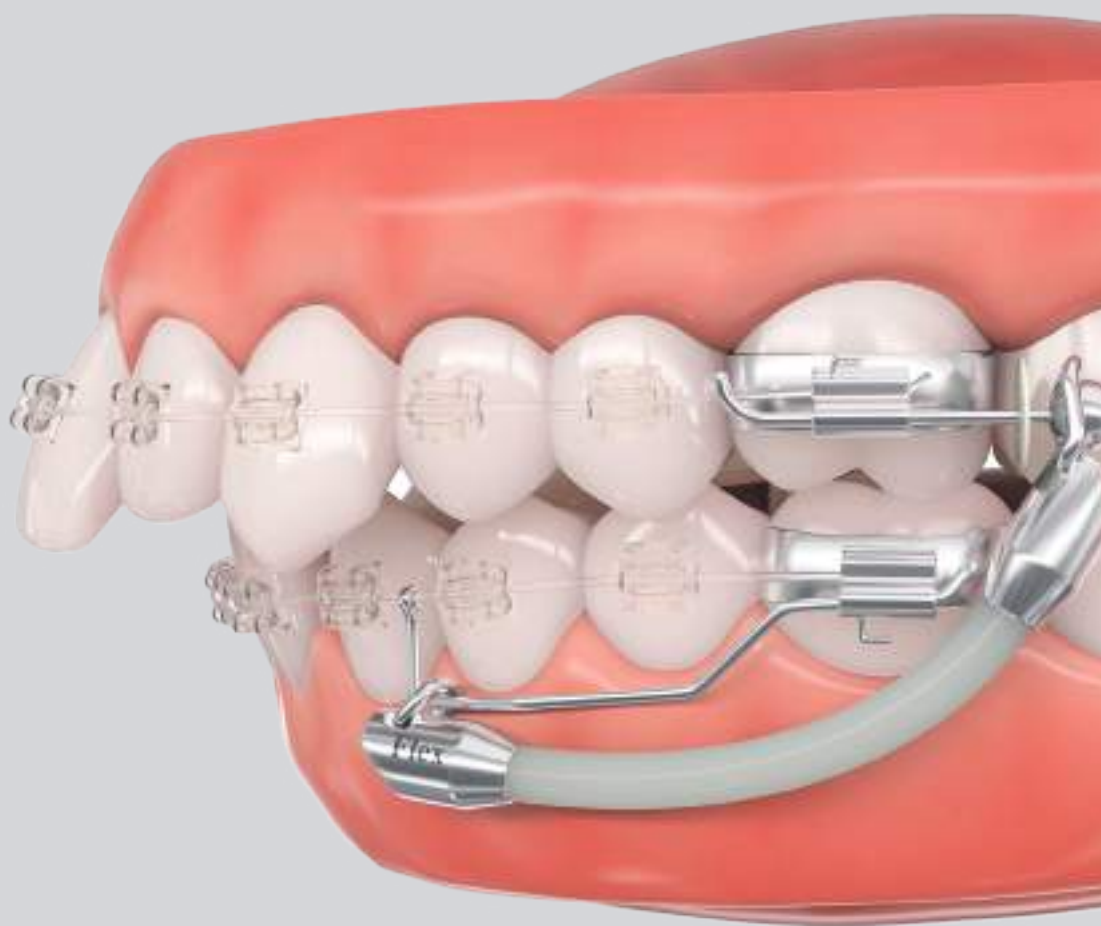

Flex Developer 2.0 (FD)

Flex Developer 2.0 (FD) is a highly efficient Class II treatment device that achieves tooth movement and also triggers mandibular growth.

Due to its tension it causes a mesial movement of the teeth in the lower jaw and a distalization of upper teeth. In doing so, it animates the patient to hold the lower jaw in front of him or her, which causes mandibular growth, as with the Herbst appliance. Due to its flexibility, tooth contact in centric occlusion is still possible.

Even after many millions of bending cycles, the

therapeutically effective force is fully retained, thus enabling class II corrections in the shortest possible time.

The spring effect is generated by a break-resistant, permanently flexible polyamide rod. The FD 2.0 can be shortened to any desired length and thinned to any desired diameter. Thus, forces between 50-1.000 cN (cN ~ g) can be adjusted.

Since the FD 2.0 is attached to a partial bow in the mandible, which transmits the mesializing force to the molars, it is especially suitable for closing gaps in the mandible.

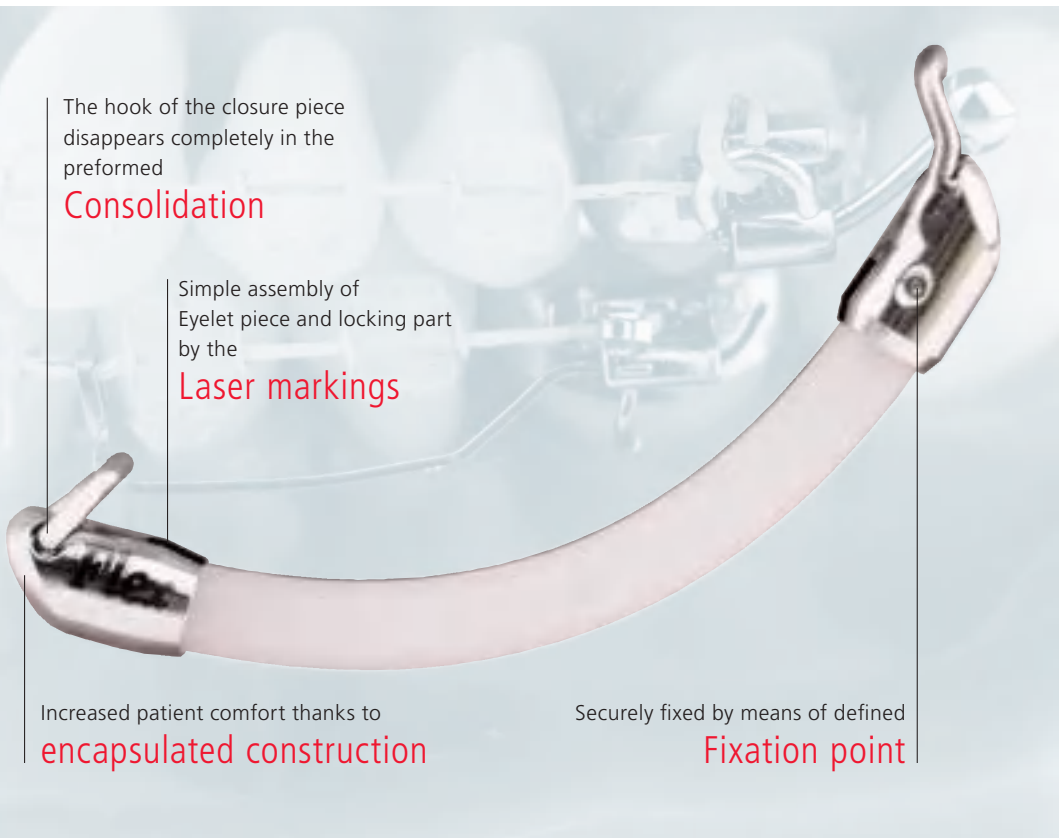

The hook of the closure piece disappears completely in the preformed

Consolidation

Simple assembly of Eyelet piece and locking part by the

Laser markings

Increased patient comfort thanks to **encapsulated construction**

Securely fixed by means of defined **Fixation point**

The FD 2.0 leads to physical tooth movements of up to 1 mm per month and can also be used on one side.

What is new in Flex Developer 2.0:

- Installation of the slip sheet and distance measurement as before
- The polyamide rod is inserted into the tube of the gauge and cut off at the front edge of the end loop piece with the razor-sharp separating blade of the FD-Cutter.
- Push the end eyelet piece completely open and

align the two laser markings.

- Press the fixing point with the press mandrel of the FD pliers, which clamps the locking piece.
- Close the hook of the locking piece. The hook disappears completely in the lateral recess.



Flex Developer - Video



Flex Developer 2.0 accessories



FD 2.0 box variable (S)
(5 items left, 5 items, right FD),
complete with sliding arches



FD 2.0 pin pliers (S) to secure the
locking piece



FD sliding arch left/right



FD locking cap left/right



FD pin



Twist torque working key (S)
for fine adjustment of the sliding
arch (p. 45)



FD 2.0 cutter (S) to shorten the
spring rod



FD 2.0 ruler (S) for distance meas-
urement in the mouth and exact
shortening of the spring rod

Article no.	Designation & contents
10859	Flex Developer 2.0 starter set
10860	Flex Developer 2.0 box, variable length, 5 pairs/pack
10904	Flex Developer 2.0 box, right side, 10 items/pack
10905	Flex Developer 2.0 box, left side, 10 items/pack
10867	FD 2.0 Pin pliers
10875	FD 2.0 Cutter
10884	FD 2.0 Ruler
10171	FD sliding arch right, 5 pcs/pkg
10172	FD sliding arch left, 5 pcs/pkg
11083	FD locking cap right, 10 pcs/pkg
11082	FD locking cap left, 10 pcs/pkg
11080	FD pins, 10 pcs/pkg

Flex Developer 2.0 Starterset

Article no.	Name & content
1. Flex Developer 2.0	
10860	FD Flex Developer Box 2.0, variable length, 5 pairs/pack
2. Tools	
10867	FD 2.0 Pin Crimping Pliers
10884	FD 2.0 Ruler
10875	FD 2.0 Cutter

Working key set

Consisting of a torque measuring key for determining torque ratings in the case of torque and forces in the case of elastic bands or springs during an orthodontic treatment.

Use of the working key

Third-order bends in the straight wire system also possible between 2 brackets.

Article no.	Designation & contents
10143	Twist torque working key, silver



Herbst *Developer*

Simple and effective support of skeletal mandibular growth!

- **Fast chairside insertion**
- **High patient comfort as a result of ergonomic construction**
- **Sideways chewing movements also possible**
- **No reworking required**

www.herbst-developer.com





Herbst Developer (HD)

The Herbst Developer (HD) is a fixed orthodontic device which is mainly used for skeletal treatment of distal bite (growth promotion of mandible).

While usual Herbst hinges (moulded, soldered) are introduced into the mouth in isolation and only allow the patient minimal lateral movement, the Herbst Developer is used at the headgear tube of the molar bands and on a partial arch for fixed appliance. As it corresponds to a ball joint at both ends, lateral chewing movements are also possible for the patient.

Like the Flex Developer 2.0, the Herbst Developer also glides back on the partial arch when the mouth is opened. However, as it can also lengthen like a telescope, there is double the security when the mouth is opened.

The easily bent square-edged telescope can be adjusted to the desired length and its slim design and curved form make it ideal for fitting into the lateral oral vestibule. The posterior part of the HD (guide tube) is fixed to the headgear tube using a pin bent round it.

The anterior part (glide rod) is fixed with a lug to the partial arch. This is opened and closed with simple pressure from forceps, so insertion and removal is carried out quickly and comfortably.

To support the therapy with the Herbst Developer, bite blocks on the front teeth are used as standard. These can be produced quickly and easily with the Mini Mold bite block mold.

Herbst Developer Advised basic equipment

Article no.	Name & content
1. Herbst Developer	
10541	Herbst Developer, 1 pair, incl. sliding arch and pin, distance clips 2× 2 mm, 2× 3.5 mm und 2× 5 mm
2. Accesories	
10845	HD Pliers, for closing HD-distance clips
10548	HD Ruler, for determining the pipe length
10292	Diamond cutting disk, small
10609	Mini Mold with Orthoholder set, 2 items bite block molds, 1 item bite block holder

Herbst Developer Accesories



10541 HD Herbst Developer
2 pairs including sliding arches and pins



HD distance clips
Lengths: 2 / 3.5 / 5 mm

Article-Nr.	Description & Content
10891	Herbst Developer starter set
10541	Herbst Developer, 1 pair Incl. sliding arch and pin, distance clips (2 x 2 / 2 x 3.5 / 2 x 5 mm)
10540	HD pins, 10 pcs/pkg
10548	HD ruler
10845	HD forceps
10609	Mini Mold with Orthoholder set, 2 items bite block molds, 1 item bite block holder
10544	Mini Mold bite block molds, 2 Stk./Pkg.

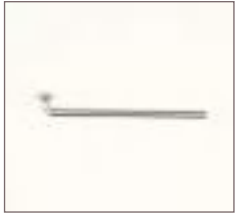

10540 HD Pin



10548 HD ruler for distance measurement in the mouth



10845 HD forceps for closing the distance clips



10609, 10544 Mini Mold with Orthoholder for bite block molds



Herbst Developer - Video

Mini Mold with Orthoholder set

Front tooth bite blocks for the intrusion of front teeth are produced in seconds using the Mini Mold.

At 8.4 mm, they are long enough to be simply shortened if needed. Existing bite blocks can also be simply lengthened by reapplying the Mini Mold. The Orthoholder runs in parallel to the bite block level which guarantees continuously constant results. The lateral auxiliary line ensures that all bite blocks are at the same height. **Tip:** Simply mark the auxiliary line additionally with a black marker.

For reasons of abrasion, non-filled light-curing materials are recommended (e.g. Heliosit).

Article no.	Designation & contents
10609	Mini Mold with Orthoholder set 2 items bite block molds, 1 item bite block holder
10544	Mini Mold bite block molds, 2 items/pack



Application of the mini mold with the Orthoholder

Piggy back spring

The piggy back spring creates space at a number of distances!

- **Fast, simple insertion and activation**
- **Many application possibilities**
- **Six colour-coded sizes**

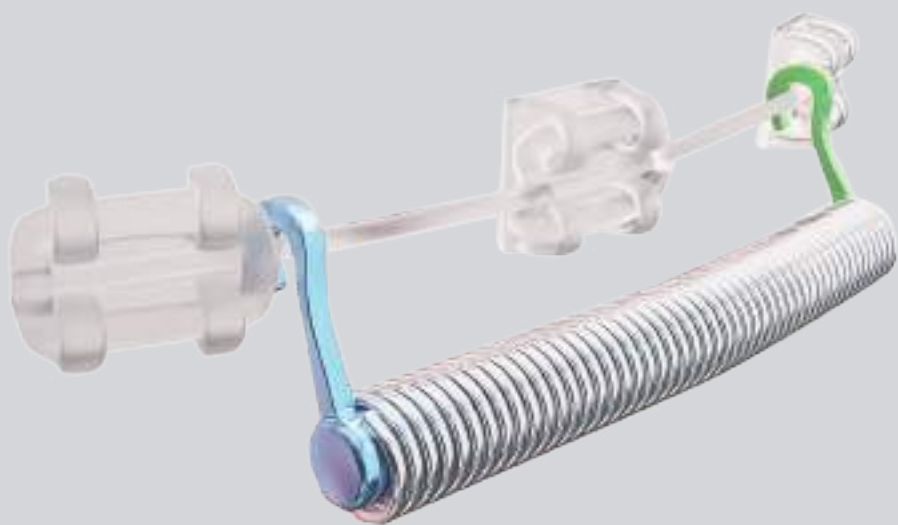

Piggy back spring

Clampable tension spring element

During the levelling phase, there is often a need to apply pressure to crowded teeth. Despite brackets, the piggy back spring can be attached in seconds without removing the treatment arch. Squeeze hook and - all done. The simultaneous use of brackets in the area of crowding is thus possible.

6 sizes

Six different lengths enable space to be gained from the individual tooth region to the canine-canine distance. Different colours are assigned to the individual sizes. Approx. 200 cN force development (progressively decreasing) with full compression

Indications

- Space gained in the case of crowded front teeth
- Gap opening in the area of the posterior teeth
- Derotation of teeth
- Alignment of lingually tilted mandibular canine teeth (CC)
- Mesialising of posterior teeth



Before



After 7 weeks

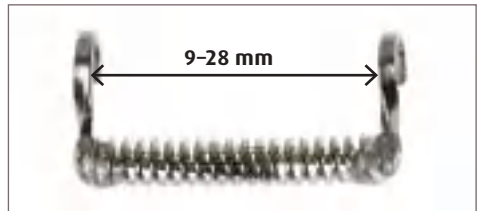



10215 Piggy back spring F1, transparent, bypass of front tooth bracket

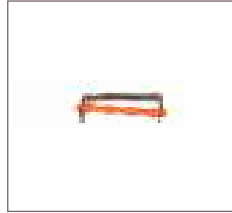

10216 Piggy back spring B1, orange, bypass of side tooth bracket



10218 Piggy back spring F2, red, bypass of 2 front tooth brackets



10220 Piggy back spring B2, blue, bypass of 2 side tooth brackets



10221 Piggy back spring U3, green, universal

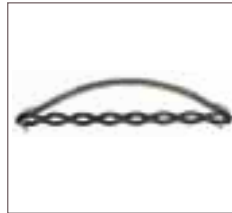

10226 Piggy back spring CC, black, canine-canine distance

Article no.	Designation & contents
10109	Piggy back spring starter set, 1 item each size (F1, B1, F2, B2, U3, CC)
10255	Piggy back spring assortment, 5 items each size (F1, B1, F2, B2, U3, CC)
10215	Piggy back spring individual box F1, transparent, 5 items/pack
10216	Piggy back spring, individual box B1, orange, 5 items/pack
10218	Piggy back spring, individual box F2, red, 5 items/pack
10220	Piggy back spring, individual box B2, blue, 5 items/pack
10221	Piggy back spring, individual box U3, green, 5 items/pack
10226	Piggy back spring, individual box CC, black, 5 items/pack



Huckepackfeder - Video

Reflex ➤ *Communicator*

**The reliable patient mirror
for dialogue and trust!**

- **Fast, direct communication between the handler and the patient**
- **Simple operation**
- **Easy assembly**



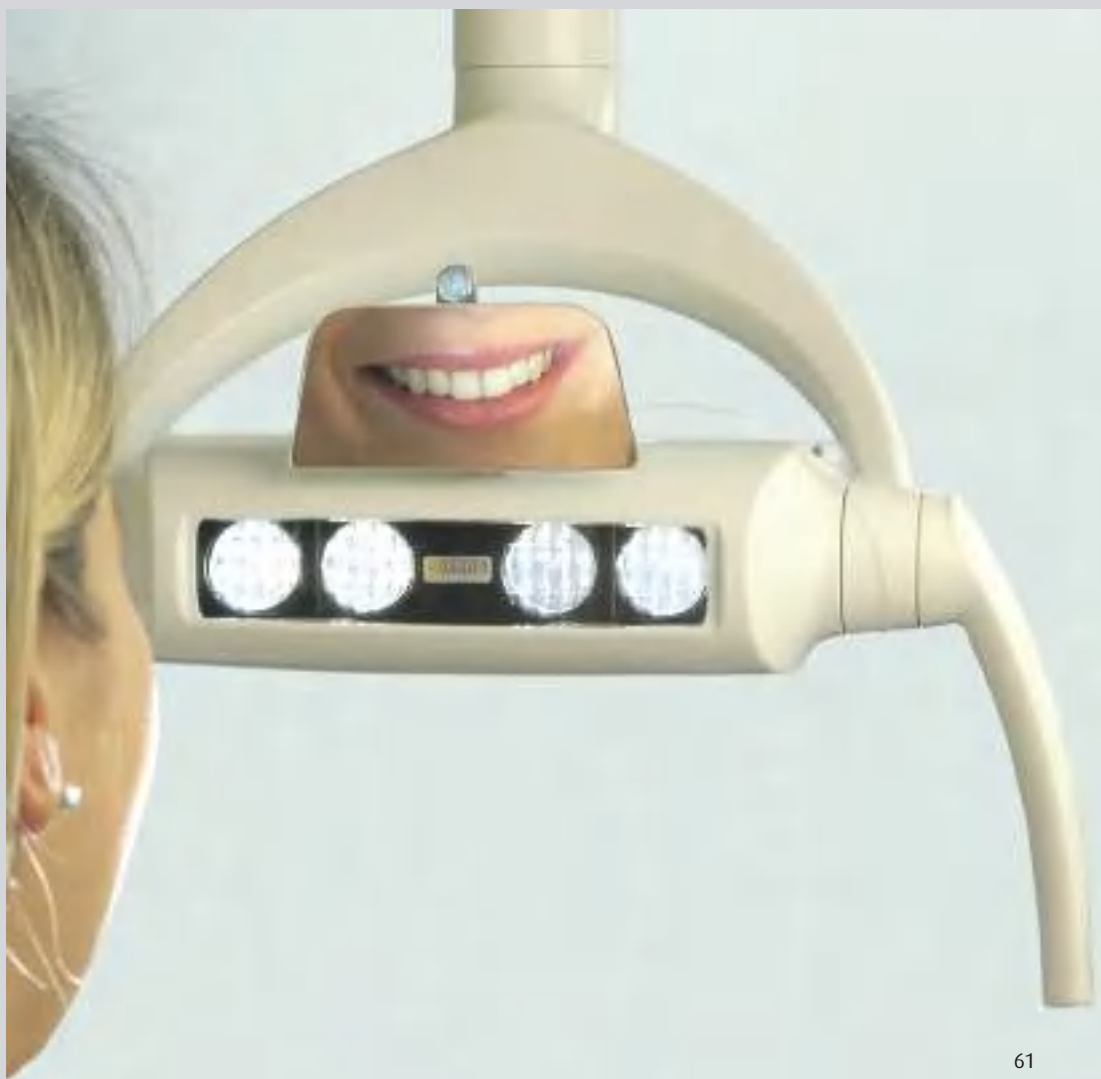

Reflex Communicator patient mirror

The Reflex Communicator patient mirror, which has been proven for years on treatment lamps with halogen technology, is now also available for the Sirona LEDview.

The Reflex Communicator LED patient mirror simply takes over the function of facilitator between the physician and the patient.

The patient can follow with his/her own eyes what is happening in his/her mouth. This leads to trust without using many words.

The handler can fold away the mirror at any time at the touch of a button. Thus anything anxiety-producing remains invisible.

What is new about the Reflex Communicator LED:

- Attractive, adaptive design for the Sirona LED-view
- Simple, secure adhesive attachment on the lamp housing using a positioning pin and safety thread.
- Individually customizable adjustment force
- Pivoting range up to 35°

Areas of application

- Orthodontics
- Oral hygiene demonstrations
- Advice consultations
- Parodontal sessions
- Relieves anxiety for children and adults



Reflex Communicator LED

The Reflex Communicator LED is a light-mounted, foldable patient mirror for the Sirona LEDview.

Article no.	Designation & contents
10818	Reflex Communicator LED patient mirror with adapter for Sirona LEDview



Being able to watch during the treatment creates trust

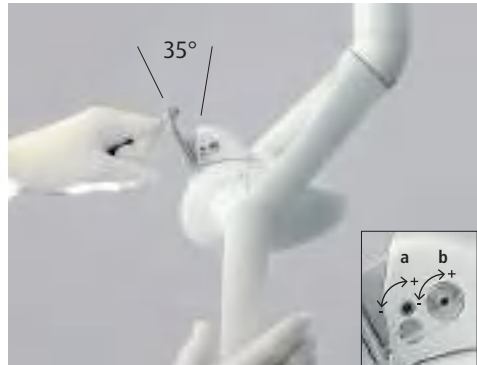

Pivoting range up to 35°; adjustment force and end stop can be adjusted:
a) Adjustment of the mirror swinging clamping,
b) Adjustment of the angle of the mirror swinging

Reflex patient mirror 65/90 mm für Sirona LEDview Plus & further halogen lamps

Proven round design! Our classic, round Reflex patient mirror fits on the current and excellent Sirona LEDview Plus dental light.

The round Reflex patient mirror fits on the Sirona LEDview Plus as well as most older halogen lights and is very easy to install. There is an adapter for the Sirona fantastic.

Article no.	Designation & contents
10102	Reflex patient mirror, ø 90 mm
10232	Reflex patient mirror, ø 90 mm, with Sirolux adapter
10103	Reflex patient mirror, ø 65 mm
10104	Reflex patient mirror, ø 65 mm, with Sirolux adapter



**Usable for
Sirona
LEDview Plus**

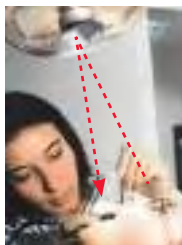

The patient sees what is happening in his/her mouth.

Siziliana patient protection glasses

Tinted, extremely scratch-proof, anatomic fit. Glare protection and maximum protection from injuries, 100% UV-absorbing

Article no.	Designation & contents
10099	Siziliana patient protection glasses



Intraoral Photography

Accessories for professional dental photography!

- **Dental mirrors & contrastors**
- **Lip & cheek retractors**



Ultrabright Dental Mirrors

The Ultrabright Dental Mirrors aim to reflect almost 100%. Their special shape and various sizes are the perfect combination of ideal reflective surfaces, safe handling and best patient comfort. The silicon handle can be sterilised. It is also colour-coded and ensures safe handling, even when removing the mirror through the resulting hollow*.

Technical information

- Highly scratch-resistant
- 22 x surface reflection
- Level of reflection almost 100%
- Surface protection in hollow*
- Very faithful colour reflection
- Temperature resistant up to 200° C
- Corrosion resistant
- Safe grip thanks to colour-coded Silicon handle

Article no.	Designation & contents
10741	Mirror 12 occlusal 65 mm ultrabright II - red handle
10743	Mirror 13 occlusal 70 mm ultrabright II - blue handle
10745	Mirror 15 buccal 40 mm ultrabright II - green handle
10746	Mirror 16 buccal 30 mm ultrabright II - orange handle
10747	Mirror 17 occlusal 75 mm ultrabright II - yellow handle



*Scratch-resistant through hollow position

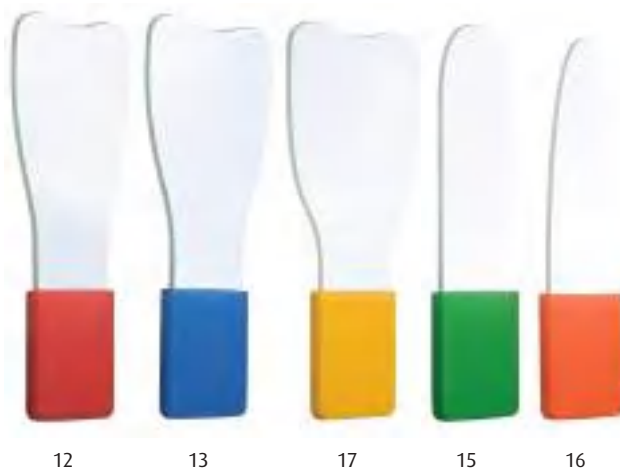

Contrastors

The contrastors are indispensable for professional, intraoral photography. We distinguish between contrastors for front teeth images and occlusal contrastors which also serve as excellent cheek and lip retractors. They consist of matt black coated aluminium, are available in different sizes with colour-coded, sterilisable silicon handles and are rounded off in the shape of the palate at the top.

Article no.	Designation & contents
10748	Contrastor 30 labial 50 mm – green handle
10749	Contrastor 31 labial 55 mm – orange hand-
10750	Contrastor 32 labial 65 mm – red handle
10751	Contrastor 35 occlusal 51 mm – black
10752	Contrastor 36 occlusal 53 mm – red handle
10753	Contrastor 37 occlusal 60 mm – blue hand-
10754	Contrastor 38 occlusal 65 mm – green handle

Technical information

- Black contrastors for occlusal and front tooth use
- Different sizes with colour-coded silicon handle, sterilisable
- Contrastors allow clean free images, e.g. the front teeth

Tip: For our images, the cheek retractors are held by the patient, the contrastor is placed and inserted. This leaves the hands free for taking the photograph.



Lip Retractor

The excellent functionality of these lip retractors is impressive. Available in sizes “small” (49 mm) and “normal” (59 mm) width. Autoclavable at 121°C.

Article no.	Designation & contents
10822	Lip Retractor for occlusal exposure, normal, 1 pcs.
10825	Lip Retractor for occlusal exposure, small, 1 pcs.

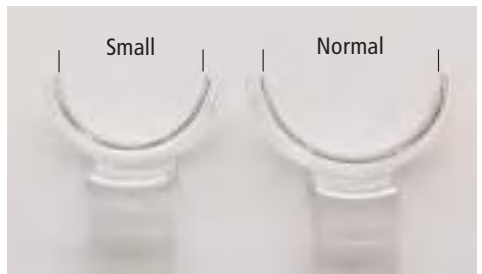

Cheek Retractor

The cheek retractors make overview images easy. They are available in different shapes and sizes. Autoclavable at 130° C and 3 bar.

Article no.	Designation & contents
10755	Cheek Retractor 51 for children, 2 pcs/pkg
10756	Cheek Retractor 52 for adults, 2 pcs/pkg
10796	Cheek Retractor 53, 2 pcs/pkg
10795	Cheek Retractor 54, 2 pcs/pkg
10757	Cheek Retractor 56, 2 pcs/pkg
10758	Cheek Retractor 59, 2 pcs/pkg
10759	Cheek Retractor 60, 2 pcs/pkg



10755 Cheek retractor 51, self-tensioning, holding width 34 mm.



10756 Cheek retractor 52 self-tensioning, holding width 46 mm



10757 Cheek retractor 56, holding width 30/43 mm



10758 Cheek retractor 59, holding width 34 mm



10796 Cheek retractor 53, holding width 34/40 mm



10795 Cheek retractor 54, holding width 35/50 mm



10759 Cheek retractor 60, holding width 46 mm

Head & chin caps

**Functionally proven quality
in a wide variety of colours**

- **Progenie head/chin cap set**
- **Vertex vertical head-chin cap set**
- **Combiquick head caps**
- **Accessories**



Progenie head/chin cap set

Solid construction & fashionable colours

The head cap is solidly constructed, colour-fast and can be easily washed, with no shrinking. Wide straps guarantee comfortable distribution of pressure. The number of colour combinations allows each child to find his or her favourite combination (16 variants per size).

The spring modules (up to 600 g) are extra flat and



have an unbreakable metal safety clip. Oval holes facilitate mounting the chin cup.

The chin cup has a very good ventilation and, because of its so-called "swim ring effect", it offers an enlarged support surface without involving the tip of the chin. As a result, it can be worn round the clock.

Its outer arms are specially rounded to prevent the risk of injury and snagging.

Indications

- For early treatment of class III,
- For treatment of maxilla/mandible
- For growth discrepancies

Article no.	Designation & contents	
10118	Progenie head/chin cap set, black/red	
10120	Progenie head/chin cap set, black/lilac	
10122	Progenie head/chin cap set, red/light blue	
10123	Progenie head/chin cap set, red/black	
10124	Progenie head/chin cap set, red/dark blue	
10125	Progenie head/chin cap set, light blue	
10126	Progenie head/chin cap set, light blue/yellow	
10127	Progenie head/chin cap set, dark blue	
10128	Progenie head/chin cap set, dark blue/red	
10130	Progenie head/chin cap set, lilac/black	
10132	Progenie head/chin cap set, pink/lilac	
10133	Progenie head/chin cap set, denim	
10135	Progenie head/chin cap set, neon yellow/black	
10136	Progenie head/chin cap set, neon green	
10144	Progenie head/chin cap set, light blue/red	
10119	Progenie head/chin cap set, black	

Contents of set

- Washable head cap
- Vented chin cup (OPAC)
- 1 pair safety modules 150–600 g

Progenie head cap

Available in 16 colour combinations, comfortable to wear, durable and easily washable without shrinking. For class III treatments.



Article no.	Designation & contents	
10023	Head cap, black	■
10025	Head cap black/red	■ ■
10027	Head cap black/lilac	■ ■
10029	Head cap red/black	■ ■
10030	Head cap red/dark blue	■ ■
10031	Head cap light blue	■
10032	Head cap red/light blue	■ ■
10033	Head cap light blue/red	■ ■
10034	Head cap light blue/yellow	■ ■
10035	Head cap dark blue	■
10036	Head cap dark blue/red	■ ■
10038	Head cap lilac/black	■ ■
10040	Head cap pink/lilac	■ ■
10041	Head cap jeans	■
10043	Head cap neon yellow/black	■ ■
10044	Head cap neon green	■

Vertex – vertical head/chin cap set

Vertex is a purely vertical chin cap with a vertical tensile direction just lateral to the orbital rim. This results in a lifting of the chin with simultaneous relief in the mandibular joint region.

The head cap (Combiquick) gets its precise snug fit by positioning the strap beneath the cranial equator through two individually adjustable, concealed Velcro fasteners. This also enables the head cap to have a high degree of force without shifting. Forces from 150 to 600 cN (grams) can be adjusted at the safety modules.

The long outer arms of the chin cup prevent constriction at the cheeks. As a result of the increased pressure, the molars are intruded and this effect is increased by the bite blocks. In combination with posterior bite blocks and spikes in the area of the front teeth, Vertex is the ideal treatment device for a frontally or circularly open bite.

In addition, the vertical chin cap ensures that the mouth is gently closed (at night), which helps persons with chronic mouth breathing change to nasal breathing.

Since the application of force is exclusively skeletal (chin region), Vertex is also suitable for postoperative use following orthognathic corrections. The use of the vertical chin cap is successful particularly in cases of threatened postoperative open bite.

Article no.	Designation & contents
10074	Vertex vertical head/chin cap set
10075	Vertex vertical head/chin cap set
10077	Vertex vertical head/chin cap set



Indications

- For cases of frontally or circularly open bite (particularly in combination with spikes and molar bite blocks)
- Mouth closure in persons with habitual mouth breathing
- Postoperatively following dysgnathia corrections and threatened open bite.

Contents of set

- Head cap
- Chin cup with long outer arms
- 1 pair Helix safety modules

Indigo head cap

The Combiquick head cap is the basis for the vertical "Vertex" chin cap. Its clever closure concept ensures a secure hold, even on persons with long hair. A high degree of wear comfort enables unimagined therapeutic possibilities.

The head cap gets its precise snug fit by positioning the strap beneath the cranial equator through two individually adjustable, concealed Velcro fasteners. This also enables the head cap to have a high degree of force without shifting.

Protraction face masks (see photo in lower right) can be easily and quickly secured to the Combiquick head cap using 4 rivets. This ensures a secure hold and greater distribution of pressure. No annoying shifting during sleep.

Tip: For improved cleaning, the forehead area of the Combiquick head cap can be wrapped with medical gauze which is changed at regular intervals.

Article-Nr.	Description & Content
10069	Indigo Head Cap, size S
10070	Indigo Head Cap, size M
10071	Indigo Head Cap, size L
11135	AD Protraction Mask



Chin caps & Helix safety modules

Chin caps

- A high degree of wear comfort through the ring-shaped cotton lining creates a pressure zone which is 5 times as large, as well as very good ventilation and skin tolerance.
- The hooks are small and rounded, for improved safety.
- Available in 7 colours, pierced and perforated.

Short outer arms

- For Progenie head/chin cap set

Long outer arms

- For Vertex vertical head/chin cap set (7-cm long outer arms)



Chin cap with short holding arms



Chin cap with long holding arms



Helix safety modules

Helix safety modules

The safety modules are extra flat and have an unbreakable metal safety clip. Oval holes facilitate mounting the chin cup.

Article no.	Designation & contents
10055	Chin cap, perforated, short outer arms, white 
10056	Chin cap, perforated, short outer arms, yellow 
10057	Chin cap, perforated, short outer arms, orange 
10058	Chin cap, perforated, short outer arms, red 
10059	Chin cap, perforated, short outer arms, pink 
10060	Chin cap, perforated, short outer arms, blue 
10061	Chin cap, perforated, short outer arms, green 
10062	Chin cap, perforated, long outer arms, white 
10063	Chin cap, perforated, long outer arms, blue 
10081	Helix safety modules, black, 1 pair 
10082	Helix safety modules, white, 1 pair 
10083	Helix safety modules, blue, 1 pair 
10084	Helix safety modules, pink, 1 pair 
10085	Helix safety modules, yellow, 1 pair 
10086	Helix safety modules, green, 1 pair 

Additional details about the Helix safety modules:

- adjustable from 150 to 600 g
- metal clip
- sturdy
- very flat

Polishing & grinding tools

**Innovative individual products –
for treatment and surgery**

- **Gyrolan grinding and polishing wheels**
- **Gyroform fleece polisher**



Gyrolan grinding and polishing wheels

Gyrolan grinding and polishing wheels are characterised by their cooling air ventilation during the processing operation. As a result, they are particularly suitable for processing heat-sensitive materials such as thermoforming films (e.g. positioners, mouth protection), acrylic (retainers), rubber and foam rubber (bunion pads and wedges to be worn between the toes, etc.) and eyeglass frames but also for smoothing and thinning freshly cut, thickened nails (manicures and pedicures).

Tip: If the wheels are very worn, they can continue to be used without the supporting disks for difficult detail work. Always wear protective goggles and a fine particle mask!

Possible applications

- Dental field
- Orthopaedic field
- Optometry
- Manicures and pedicures

Ideal rpm: 10,000 rpm

The Gyrolan wheels are produced in 4 different grades:



Assortment 4 x 6 wheels (fine, medium, coarse, very coarse)

Article no.	Designation & contents
10020	Gyrolan grinding/polishing wheels, assortment, contents: 6 items fine, 6 items medium, 6 items coarse, 6 items very coarse, 4 items washers, 2 items mandrels
10021	Gyrolan grinding/polishing wheels, fine, 25 items/pack, incl. 4 washers and 2 mandrels
99999	Gyrolan grinding/polishing wheels, medium, 50 items/pack, incl. 4 washers and 2 mandrels
10089	Gyrolan grinding/polishing wheels, coarse, 25 items/pack, incl. 4 washers and 2 mandrels
10090	Gyrolan grinding/polishing wheels, very coarse, 25 items/pack, incl. 4 washers and 2 mandrels

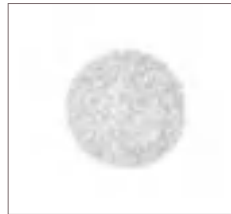

10021 Fine (white)
ideal for polishing thermoplastic surfaces, only minor abrasion, high smoothing function



99999 Medium (burgundy)
extremely long service life due to Kevlar fibres, for reworking deep-draw materials, particularly for smoothing and rounding sharp edges



10089 Coarse (brown)
ideal for reworking soldered areas or metal surfaces; very suitable for matt finishing of surfaces

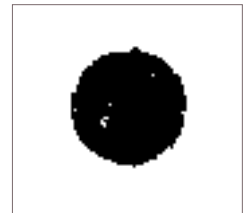

10090 Very coarse (red-brown)
ideal for removing soft linings on the inside in the case of full dentures and for smoothing metal edges, burnishing metal surfaces.

Additional products

Individual products for treatment and surgery

- **RMbond® in an applicator syringe**
- **Bass-o-lino lingual pads**
- **Skippy patient slide-closure pouch**
- **Torpedo hard metal finishing burr**

GC Ortho Connect Flow™ - Application syringe set

Self-smoothing, light-curing resin. Ideal for covering and fixing wires. Particularly suitable for covering screw heads (can be removed again by light pressure with the cutter).

Article no.	Designation & contents
11137	GC Ortho Connect Flow 2 x 2,7 g (2 ml)



GC Ortho Connect™ - Application syringe set

Light-curing bracket adhesive for orthodontic treatment.

Article no.	Designation & contents
11152	GC Ortho Connect Light Cure Syringe Kit, 2 x 2,9 g



Skippy patient slide-closure pouch

Practical, transparent plastic pouch with slide closure for carrying treatment devices, documents and toothbrushes during an office visit or while on the go. A patient favourite.

Article no.	Designation & contents
10233	Skippy, patient/slide-closure pouch, for DIN A5, 10 items/pack
10306	Skippy, patient/slide-closure pouch, for DIN A5, 100 items/pack



Suggestions for filling

Hard metal finishing burr, Torpedo

For adhesive removal after DBO, gentle to enamel, long service life

Article no.	Designation & contents
10316	Hard metal finishing burr, Torpedo



Tiger Dental's Team



Dagmar Böhler

Customer Service DACH,
Accounting
T +43 5574 43 50 43
M+43 06605195375
dagmar.boehler@tigerdental.com



Julian Winsauer

Management & Dealer Support
T +43 5574 43 50 43
M+43 06605195375
julian.winsauer@tigerdental.com



Eva Diem

International customer service,
Organization of courses & lectures,
Quality Management
T +43 5574 43 50 431
eva.diem@tigerdental.com



Sarah Fenkart

Sales assistance
T +43 5574 43 50 43
M+43 06605195375
sarah.fenkart@tigerdental.com



Paula Ortiz

Design & Marketing
T +43 5574 43 50 43
paula.ortiz@tigerdental.com



Günes Akdeniz

Production
T +43 5574 43 50 43
sarah.fenkart@tigerdental.com

Tiger Dental GmbH

Belruptstraße 59
6900 Bregenz
Österreich

T +43 (0) 5574 43 50 43

E office@tigerdental.com

www.tigerdental.com

www.topjet-distalizer.com

www.powerscrew-expansion.com

www.flex-developer.com

www.herbst-developer.com

